

Chapter 9

1. a. E_1 :

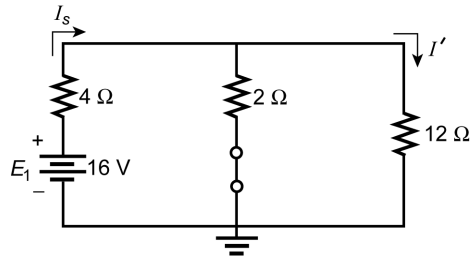

$$R_T \text{ (from source)} = 4 \Omega + 2 \Omega \parallel 12 \Omega$$

$$= 4 \Omega + 1.71 \Omega$$

$$= 5.71 \Omega$$

$$I_s = \frac{E_1}{R_T} = \frac{16 \text{ V}}{5.71 \Omega} = 2.8 \text{ A}$$

$$I'_{12\Omega} = \frac{2 \Omega (2.8 \text{ A})}{2 \Omega + 12 \Omega} = 0.4 \text{ A}$$

E_2 :

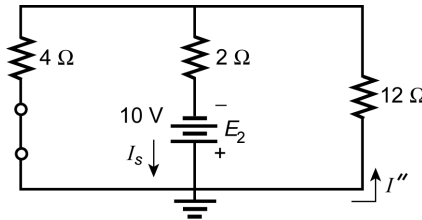

$$R_T \text{ (from source)} = 2 \Omega + 4 \Omega \parallel 12 \Omega$$

$$= 2 \Omega + 3 \Omega$$

$$= 5 \Omega$$

$$I_s = \frac{E_2}{R_T} = \frac{10 \text{ V}}{5 \Omega} = 2 \text{ A}$$

$$I''_{12\Omega} = \frac{4 \Omega (2 \text{ A})}{4 \Omega + 12 \Omega} = 0.5 \text{ A}$$

$$I_{12\Omega} \uparrow = 0.5 \text{ A} - 0.4 \text{ A} = \mathbf{0.1 \text{ A}}$$

b.

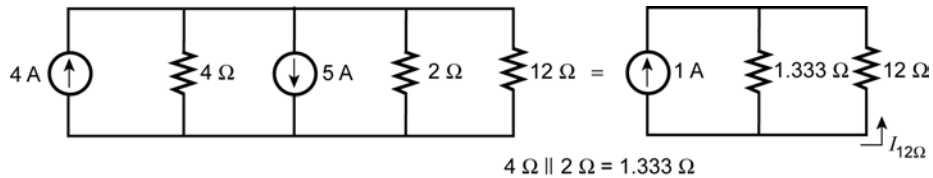

$$I_{12\Omega} = \frac{1.333 \Omega (1 \text{ A})}{1.333 \Omega + 12 \Omega} = \mathbf{0.1 \text{ A}}$$

c. the same

2.

a.

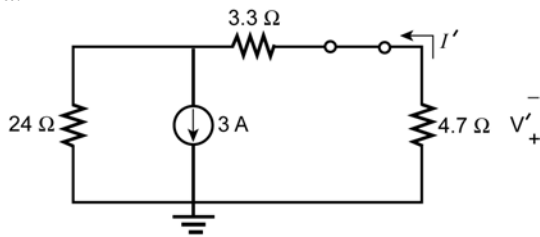

$$I' = \frac{24 \Omega (3 \text{ A})}{24 \Omega + 8 \Omega} = 2.25 \text{ A}$$

$$V' = I'R = (2.25)(4.7 \Omega) = 10.575 \text{ V}$$

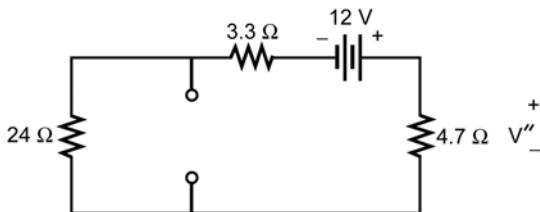

$$V'' = \frac{4.7 \Omega (12 \text{ V})}{4.7 \Omega + 3.3 \Omega + 24 \Omega} = 1.763 \text{ V}$$

$$V''_{+} = 10.575 \text{ V} - 1.763 \text{ V} = \mathbf{8.81 \text{ V}}$$

$$b. \quad P = \frac{V^2}{R} = \frac{(10.575 \text{ V})^2}{4.7 \Omega} = \mathbf{23.79 \text{ W}}$$

$$c. \quad P = \frac{V^2}{R} = \frac{(1.763 \text{ V})^2}{4.7 \Omega} = \mathbf{0.661 \text{ W}}$$

$$d. \quad P = \frac{V^2}{R} = \frac{(8.81 \text{ V})^2}{4.7 \Omega} = \mathbf{16.51 \text{ W}}$$

$$e. \quad 23.79 \text{ W} + 0.661 \text{ W} \neq 16.51 \text{ W}$$

$$24.45 \text{ W} \neq 16.51 \text{ W}$$

3. E :

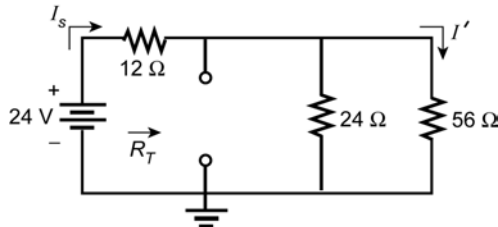

$$R_T = 12 \Omega + 24 \Omega \parallel 56 \Omega = 28.8 \Omega$$

$$I_s = \frac{E}{R_T} = \frac{24 \text{ V}}{28.8 \Omega} = 0.833 \text{ A}$$

$$I'_{56\Omega} = \frac{24 \Omega(0.833 \text{ A})}{24 \Omega + 56 \Omega} = 0.25 \text{ A}$$

I :

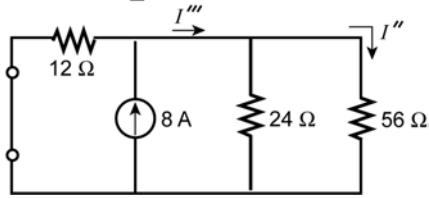

$$24 \Omega \parallel 56 \Omega = 16.8 \Omega$$

$$I''' = \frac{12 \Omega(8 \text{ A})}{12 \Omega + 16.8 \Omega} = 3.33 \text{ A}$$

$$I''_{56\Omega} = \frac{24 \Omega(3.33 \text{ A})}{24 \Omega + 56 \Omega} = 1 \text{ A}$$

$$I_{56\Omega} = I' + I'' = 0.25 \text{ A} + 1 \text{ A} = \mathbf{1.25 \text{ A} \downarrow}$$

4. E_1 :

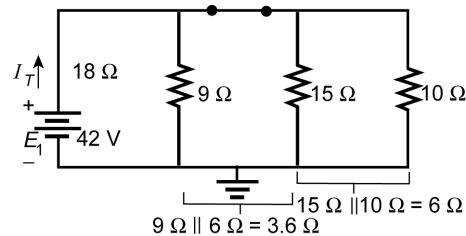

$$I_T = \frac{42 \text{ V}}{18 \Omega + 3.6 \Omega} = 1.944 \text{ A}$$

$$I_1 = \frac{9 \Omega(I_T)}{9 \Omega + 6 \Omega} = \frac{9 \Omega(1.944 \text{ A})}{15 \Omega} = 1.17 \text{ A}$$

E_2 :

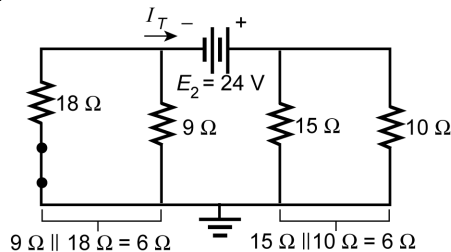

$$I_T = \frac{E_2}{R_T} = \frac{24 \text{ V}}{12 \Omega} = 2 \text{ A}$$

$$I_{24\text{V}} = I_T + I_1 = 2 \text{ A} + 1.17 \text{ A} = \mathbf{3.17 \text{ A (dir. of } I_1)}$$

5.

I:

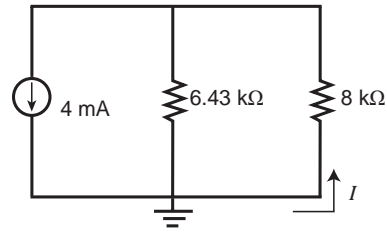
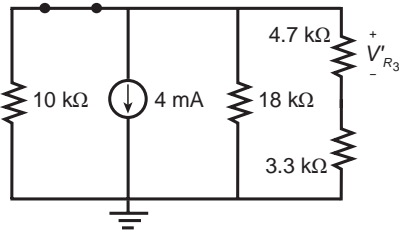

$$I = \frac{6.43 \text{ k}\Omega(4 \text{ mA})}{6.43 \text{ k}\Omega + 8 \text{ k}\Omega} = 1.78 \text{ mA}$$

$$V'_{R_3} = -IR_3 = -(1.78 \text{ mA})(4.7 \text{ k}\Omega)$$

$$V'_{R_3} = -8.37 \text{ V}$$

E:

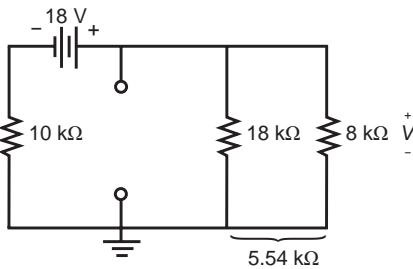

$$V = \frac{5.54 \text{ k}\Omega(18 \text{ V})}{5.54 \text{ k}\Omega + 10 \text{ k}\Omega} = 6.42 \text{ V}$$

$$V''_{R_3} = \frac{4.7 \text{ k}\Omega(6.42 \text{ V})}{4.7 \text{ k}\Omega + 3.3 \text{ k}\Omega} = 3.77 \text{ V}$$

$$\begin{aligned} V_{R_3} &= V'_{R_3} + V''_{R_3} \\ &= -8.37 \text{ V} + 3.77 \text{ V} \\ &= -4.6 \text{ V} \end{aligned}$$

6.

E:

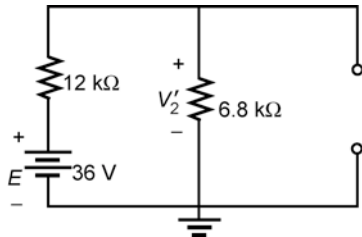

$$V'_2 = \frac{6.8 \text{ k}\Omega(36 \text{ V})}{6.8 \text{ k}\Omega + 12 \text{ k}\Omega} = 13.02 \text{ V}$$

I:

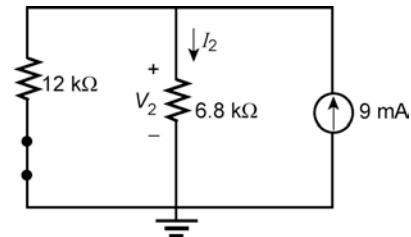

$$I_2 = \frac{12 \text{ k}\Omega(9 \text{ mA})}{12 \text{ k}\Omega + 6.8 \text{ k}\Omega} = 5.75 \text{ mA}$$

$$V''_2 = I_2 R_2 = (5.75 \text{ mA})(6.8 \text{ k}\Omega) = 39.10 \text{ V}$$

$$V_2 = V'_2 + V''_2 = 13.02 \text{ V} + 39.10 \text{ V} = \mathbf{52.12 \text{ V}}$$

7.

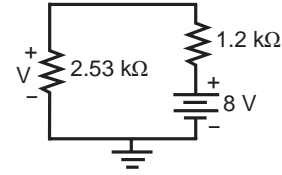
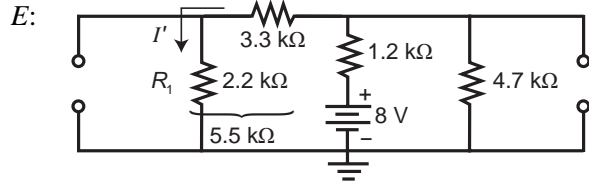

$$5.5 \text{ k}\Omega \parallel 4.7 \text{ k}\Omega = 2.53 \text{ k}\Omega$$

$$V = \frac{2.53 \text{ k}\Omega(8 \text{ V})}{2.53 \text{ k}\Omega + 1.2 \text{ k}\Omega} = 5.43 \text{ V}$$

$$I' = \frac{V}{R_1 + R_2} = \frac{5.43 \text{ V}}{5.5 \text{ k}\Omega} = 0.987 \text{ mA}$$

I (5 mA):

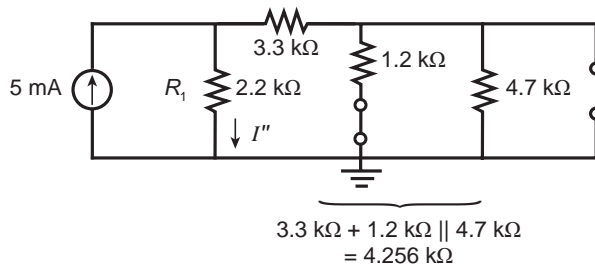

$$I'' = \frac{4.256 \text{ k}\Omega(5 \text{ mA})}{4.256 \text{ k}\Omega + 2.2 \text{ k}\Omega} = 3.296 \text{ mA}$$

I (2 mA):

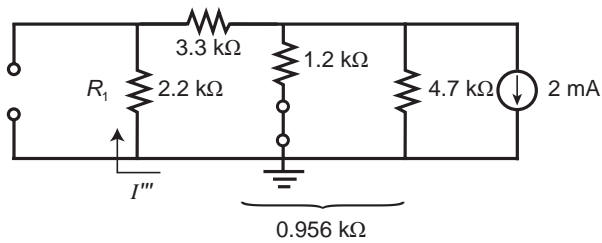

$$I''' = \frac{0.956 \text{ k}\Omega(2 \text{ mA})}{0.956 \text{ k}\Omega + 5.5 \text{ k}\Omega} = 0.296 \text{ mA}$$

$$\begin{aligned} I_{R_1} &= I' + I'' - I''' \\ &= 0.987 \text{ mA} + 3.296 \text{ mA} - 0.296 \text{ mA} \\ &= \mathbf{3.99 \text{ mA} \downarrow} \end{aligned}$$

8.

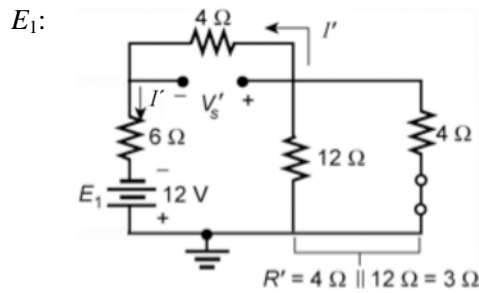

$$I' = \frac{12 \text{ V}}{12 \Omega \parallel 4 \Omega + 4 \Omega + 6 \Omega}$$

$$\begin{aligned} &= \frac{12 \text{ V}}{3 \Omega + 10 \Omega} = \frac{12 \text{ V}}{13 \Omega} \\ &= 923.1 \text{ mA} \end{aligned}$$

$$V_s^1 = IR = (923.1 \text{ mA})(4 \Omega) = 2.492 \text{ V}$$

I:

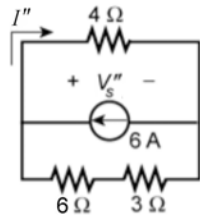
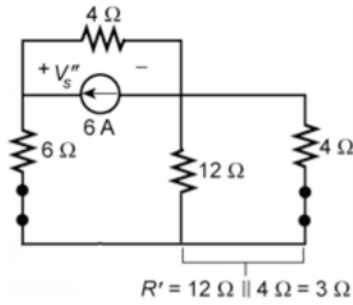

$$I'' = \frac{9\Omega(6\text{ A})}{9\Omega + 4\Omega} = 4.154\text{ A}$$

$$V_s'' = I''4\Omega = (4.154\text{ A})(4\Omega) = 16.62\text{ V}$$

E₂:

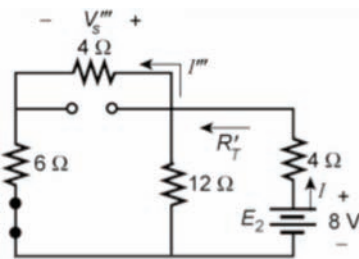

$$R'_T = 12\Omega \parallel (4\Omega + 6\Omega) = 12\Omega \parallel 10\Omega = 5.455\Omega$$

$$I = \frac{E_2}{R_T} = \frac{8\text{ V}}{4\Omega + 5.455\Omega} = 0.846\text{ A}$$

$$I''' = \frac{12\Omega(I)}{12\Omega + 10\Omega} = \frac{12\Omega(0.846\text{ A})}{22\Omega} = 0.462\text{ A}$$

$$V_3''' = I'''(4\Omega) = 0.462\text{ A}(4\Omega) = 1.848\text{ V}$$

$$V_s \text{ (polarity of } V_s'') = V_s'' - V_s' - V_s'''$$

$$= 16.62\text{ V} - 2.492\text{ V} - 1.848\text{ V} = \mathbf{12.28\text{ V}}$$

9. a. $R_{Th} = R_3 + R_1 \parallel R_2 = 4\Omega + 6\Omega \parallel 3\Omega = 4\Omega + 2\Omega = \mathbf{6\Omega}$

$$E_{Th} = \frac{R_2 E}{R_1 + R_2} = \frac{3\Omega(18\text{ V})}{3\Omega + 6\Omega} = \mathbf{6\text{ V}}$$

b. $I_1 = \frac{E_{Th}}{R_{Th} + R} = \frac{6\text{ V}}{6\Omega + 2\Omega} = \mathbf{0.75\text{ A}}$

$$I_2 = \frac{6\text{ V}}{6\Omega + 30\Omega} = \mathbf{166.67\text{ mA}}$$

$$I_3 = \frac{6\text{ V}}{6\Omega + 100\Omega} = \mathbf{56.60\text{ mA}}$$

10. a. R_{Th} :

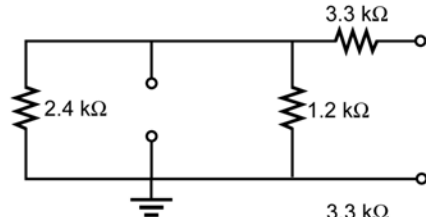

$$\begin{aligned} \leftarrow R_{Th} &= 3.3 \text{ k}\Omega + 1.2 \text{ k}\Omega \parallel 2.4 \text{ k}\Omega \\ &= 3.3 \text{ k}\Omega + 0.8 \text{ k}\Omega \\ &= \mathbf{4.1 \text{ k}\Omega} \end{aligned}$$

E_{Th} :

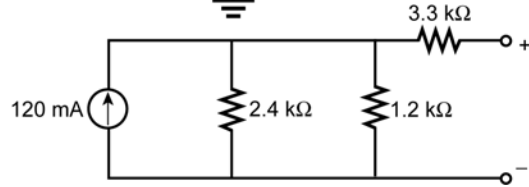

$$\begin{aligned} E_{Th} &= (120 \text{ mA})(2.4 \text{ k}\Omega \parallel 1.2 \text{ k}\Omega) \\ &= \mathbf{96 \text{ V}} \end{aligned}$$

b.

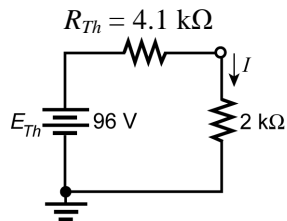

$$\begin{aligned} I &= \frac{96 \text{ V}}{6.1 \text{ k}\Omega} = 15.74 \text{ mA} \\ P &= I^2 R = (15.74 \text{ mA})^2 2 \text{ k}\Omega = \mathbf{0.495 \text{ W}} \\ R &= 100 \text{ k}\Omega: \\ I &= \frac{96 \text{ V}}{104.1 \text{ k}\Omega} = 0.922 \text{ mA} \\ P &= I^2 R = (0.922 \text{ mA})^2 100 \text{ k}\Omega = \mathbf{85 \text{ mW}} \end{aligned}$$

11. a. R_{Th} :

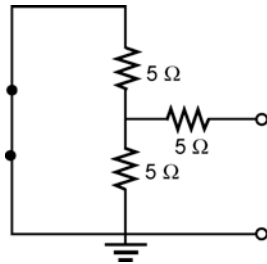

$$\leftarrow R_{Th} = 5 \Omega + 5 \Omega \parallel 5 \Omega = \mathbf{7.5 \Omega}$$

E_{Th} :

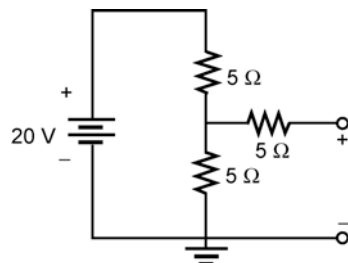

$$E_{Th} = \frac{20 \text{ V}}{2} = \mathbf{10 \text{ V}}$$

b. $R = 2 \Omega: P = \left(\frac{E_{Th}}{R_{Th} + R} \right)^2 R = \left(\frac{10 \text{ V}}{7.5 \Omega + 2 \Omega} \right)^2 2 \Omega = \mathbf{2.22 \text{ W}}$

$R = 100 \Omega: P = \left(\frac{10 \text{ V}}{7.5 \Omega + 100 \Omega} \right)^2 100 \Omega = \mathbf{0.87 \text{ W}}$

12.

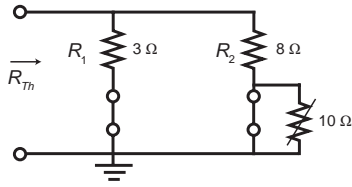

$$R_{Th} = 3 \parallel 8 \Omega = \mathbf{2.18 \Omega}$$

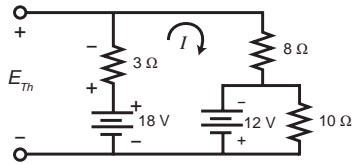

$$I = \frac{18 \text{ V} + 12 \text{ V}}{3 \Omega + 8 \Omega} = \frac{30 \text{ V}}{11 \Omega} = 2.73 \text{ A}$$

$$V_{3\Omega} = IR_1 = (2.73 \text{ A})(3 \Omega) = 8.19 \text{ V}$$

$$E_{Th} = E_1 - V_{R_1} = 18 \text{ V} - 8.19 \text{ V} = \mathbf{9.81 \text{ V}}$$

13.

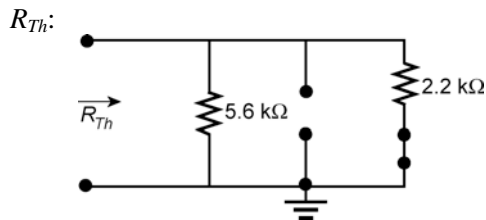

$$R_{Th} = 5.6 \text{ k}\Omega \parallel 2.2 \text{ k}\Omega = \mathbf{1.58 \text{ k}\Omega}$$

E_{Th} : Superposition:

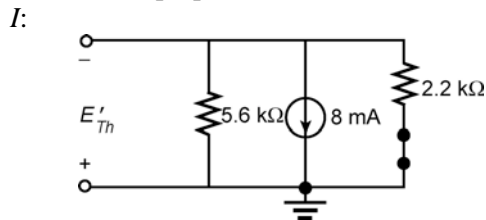

$$E'_{Th} = IR_T$$

$$= 8 \text{ mA}(5.6 \text{ k}\Omega \parallel 2.2 \text{ k}\Omega)$$

$$= 8 \text{ mA}(1.579 \text{ k}\Omega)$$

$$= 12.64 \text{ V}$$

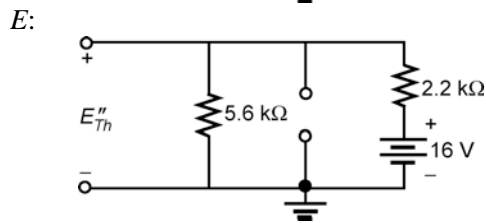

$$E''_{Th} = \frac{5.6 \text{ k}\Omega(16 \text{ V})}{5.6 \text{ k}\Omega + 2.2 \text{ k}\Omega}$$

$$= 11.49 \text{ V}$$

$$E_{Th} = 11.49 \text{ V} - 12.64 \text{ V} = \mathbf{-1.15 \text{ V}}$$

14.

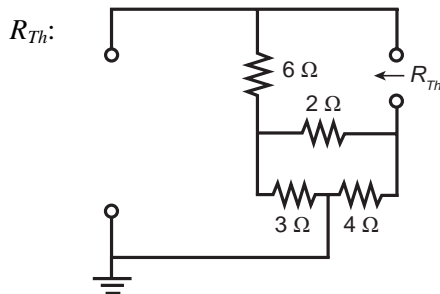

$$R_{Th} = 6 \Omega + 2 \Omega \parallel 7 \Omega = 6 \Omega + 1.56 \Omega = \mathbf{7.56 \Omega}$$

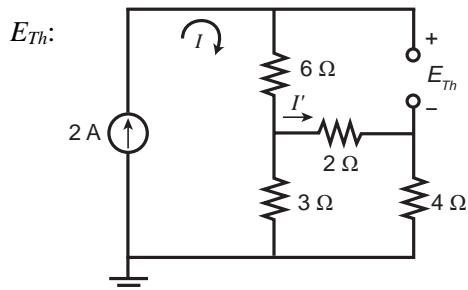

$$I = 2 \text{ A}$$

$$I' = \frac{3 \Omega(2 \text{ A})}{3 \Omega + 6 \Omega} = 0.667 \text{ A}$$

$$V_{2\Omega} = I'R = (0.667 \text{ A})(2 \Omega) = 1.333 \text{ V}$$

$$E_{Th} = I6 \Omega + V_{2\Omega} = (2 \text{ A})(6 \Omega) + 1.333 \text{ V}$$

$$= 12 \text{ V} + 1.333 \text{ V} = \mathbf{13.33 \text{ V}}$$

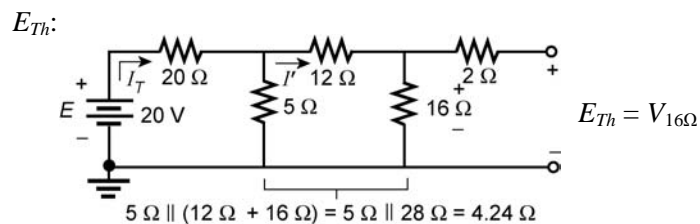
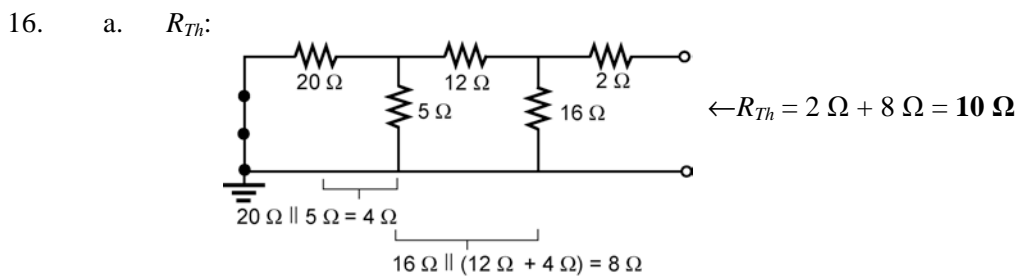
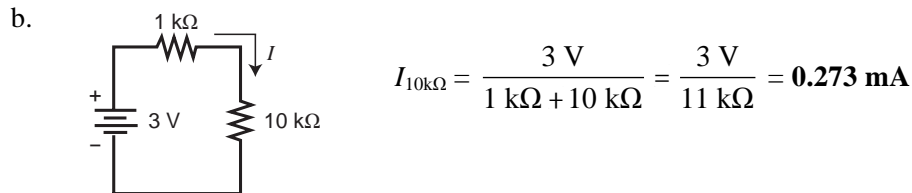
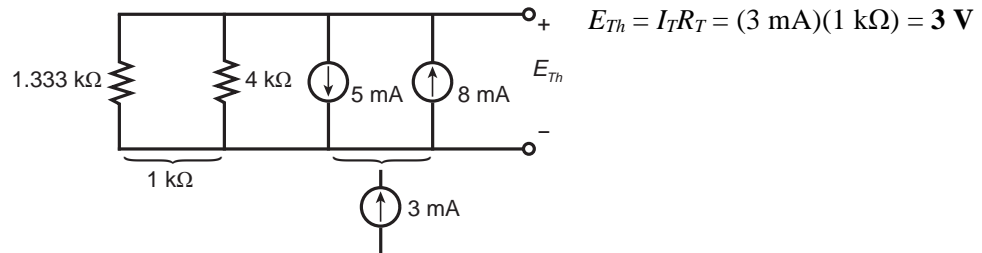
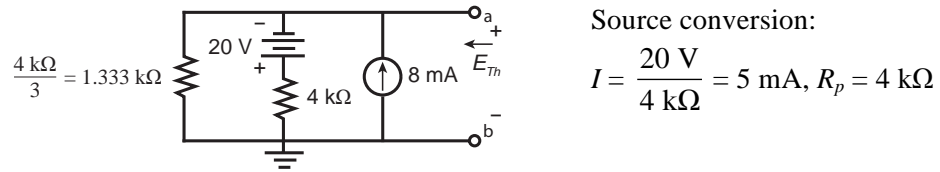
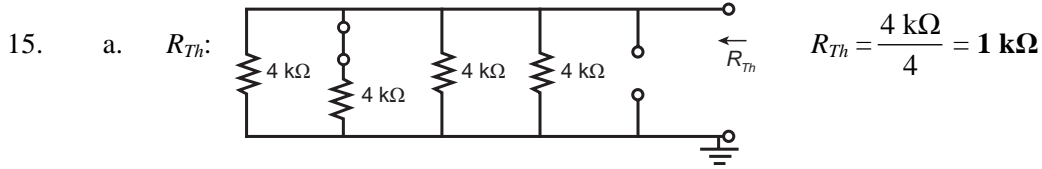

$$I_T = \frac{20 \text{ V}}{20 \Omega + 4.24 \Omega} = 825.08 \text{ mA}$$

$$I' = \frac{5 \Omega(I_T)}{5 \Omega + 28 \Omega} = \frac{5 \Omega(825.08 \text{ mA})}{33 \Omega} = 125.01 \text{ mA}$$

$$E_{Th} = V_{16\Omega} = (I')(16 \Omega) = (125.01 \text{ mA})(16 \Omega) = \mathbf{2 \text{ V}}$$

b. $20 \Omega: I = \frac{E_{Th}}{R_{Th} + R} = \frac{2 \text{ V}}{10 \Omega + 20 \Omega} = \frac{2 \text{ V}}{30 \Omega} = \mathbf{66.67 \text{ mA}}$

$50 \Omega: I = \frac{2 \text{ V}}{10 \Omega + 50 \Omega} = \frac{2 \text{ V}}{60 \Omega} = \mathbf{33.33 \text{ mA}}$

$100 \Omega: I = \frac{2 \text{ V}}{10 \Omega + 100 \Omega} = \frac{2 \text{ V}}{110 \Omega} = \mathbf{18.18 \text{ mA}}$

17. a. R_{Th} :

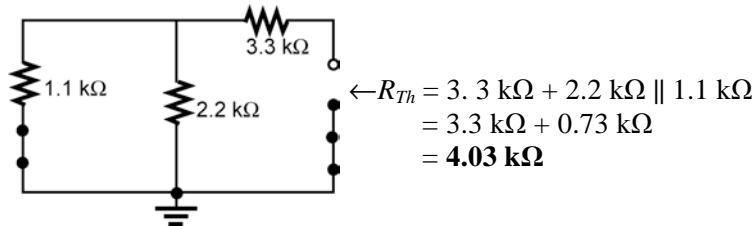

E_{Th} : Superposition:

E_1 :

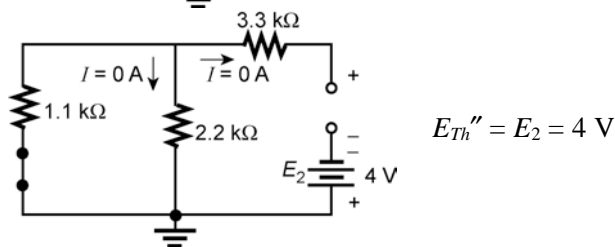
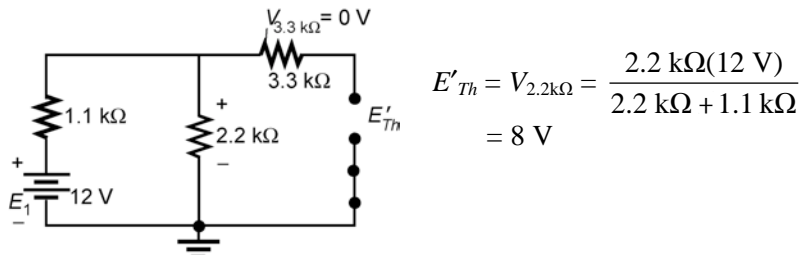

$$E_{Th} = E'_{Th} + E''_{Th} = 8 \text{ V} + 4 \text{ V} = \mathbf{12 \text{ V}}$$

b.

